

# A94

## 5MP Outdoor Mini Dome with D/N, Adaptive IR, Advanced WDR, SLLS, Fixed Lens



- 5 Megapixel
- Day & Night with Superior Low Light Sensitivity and Adaptive IR LED
- Fixed Lens with f2.8mm/F1.85
- Advanced WDR
- H.265 Compression
- Wide Angle
- Event trigger, response and notification

### ► Specifications

#### Device

Product Type	Mini Dome
Maximum Resolution	5MP
Application Environment	Outdoor
Image Sensor	Progressive Scan CMOS
Sensor Size	1/2.9 "
Effective Pixels	3096(H) X 2202(V) (6.82 MP)
Day / Night	Yes
Low Light Sensitivity	Superior
Minimum Illumination	Color: 0.4 lux; B/W: 0.05 lux (IR LED on)
Color to B/W Switch	ISP based switch, configurable
Mechanical IR Cut Filter	Yes
IR Sensitivity Range	700-1150nm
IR LED	Adaptive IR LED x 4 (850 nm)
IR Working Distance	15m
Electronic Shutter	1/5-1/64000 second (manual mode); 1/5-1/64000 second (auto mode)
Horizontal Resolution (TV Lines)	1300 TVL

S/N Ratio	56 dB
-----------	-------

## Lens

Focal Length	Fixed focal, f2.8mm
Aperture	F1.85
Iris	Fixed iris
Focus	Fixed focus
Lens Mount	Board mount
Horizontal Viewing Angle	80.04°
Vertical Viewing Angle	64.59°
Viewing Angle Adjustment	Pan: -120°-120°, Tilt: 30°-90°

## Video

Compression	H.265, H.264 (Baseline/ Main/ High profile), MJPEG
Maximum Frame Rate vs. Resolution	15 fps at 2592 x 1944 30 fps at 1920 x 1080 30 fps at 1280 x 960 30 fps at 1280 x 720 30 fps at 800 x 600 30 fps at 720 x 480 30 fps at 640 x 480 30 fps at 320 x 240
Multi-Streaming	Simultaneous dual streams based on two configurations
Bit Rate	28Kbps - 12Mbps (per stream)
Bit Rate Mode	Constant, Variable
Wide Dynamic Range	Advanced WDR (120 dB)
Image Enhancement	White Balance, Brightness, Contrast, Sharpness, Automatic gain control, Flickerless, Digital Image Stabilizer (DIS, EIS), Defogging
Digital Noise Reduction	2D + 3D DNR
Privacy Mask	4 configurable regions
Text Overlay	Yes
On-Screen Graphics	Yes
Built-in Analytics	Tampering Detection
Server-based Analytics	Object Line Counting, People Counting, Face Detection, Object Based Motion Detection, Tamper, Object Line Crossing Detection, Object Enter Area Detection, Missing Object Detection, Unattended Object Detection, Smoke Detection, Heat Map, Dwell Time, Direction Detection, Automatic License Plate Recognition, People Queue Detection, (Require PC-based or standalone IVS or ALPR Server. Contact ACTi support for recommendations on how to maximize analytical accuracy)
Image Orientation	Flip, Mirror, Rotation

## Network

Network Protocol & Service	IPv4/v6, TCP, UDP, DHCP, PPPoE, HTTP, HTTPS, DNS, DDNS, NTP, RTP, RTSP, RTCP, SMTP, FTP, IGMP, ICMP, ARP, Bonjour, UPnP, QoS, SNMP
Ethernet Port	1 x RJ-45 pigtail connector
Security	IP address filtering, HTTPS encryption, Password protected user level, Anonymous login

## Event

Event Trigger	Video motion detection (3 regions), Tampering detection
Event Response	Notify control center, Change camera settings, Command other devices, E-mail notification with snapshots, Push notification to mobile device, Save video to local storage, Upload video or snapshot to FTP server

## Integration

Unified Solution	Fully compatible with ACTi software
GPS Position	Manual setting
ONVIF Compliant	Yes, Profile S, Profile G, Profile T, Profile Q
Web Browser	IE 11
Auto Firmware Upgrade	Yes

## Interface

Local Storage	MicroSDHC, MicroSDXC Memory Card Slot (card not included, up to 128GB)
---------------	--

## General

Power Source	DC 12V (adapter not included), PoE Class 3 (IEEE802.3af)
Power Consumption	7 W (PoE), 10 W (DC)
Weight	351g (0.774lb)
Dimensions	(Ø x H): 99mm x 64.7mm (3.9" x 2.5")
Environmental Casing	Weatherproof (IP66), Vandal proof (IK10)
Mount Type	Surface
Starting Temperature	-10°C ~ 50°C (14°F ~ 122°F)
Operating Temperature	-20°C ~ 50°C (-4°F ~ 122°F)
Operating Humidity	20% - 80% RH
Approvals	CE (EN 55032 Class A, EN 55024), FCC Class A, IP66, IK10
Warranty	3 Year(s). For extended warranty offering, see <a href="http://www.acti.com/support/warranty">http://www.acti.com/support/warranty</a>

### ► Photo Indication



- 1 Power Input
- 2 Ethernet Port
- 3 Memory Card Slot
- 4 Reset Button

### ► Dimension Diagram

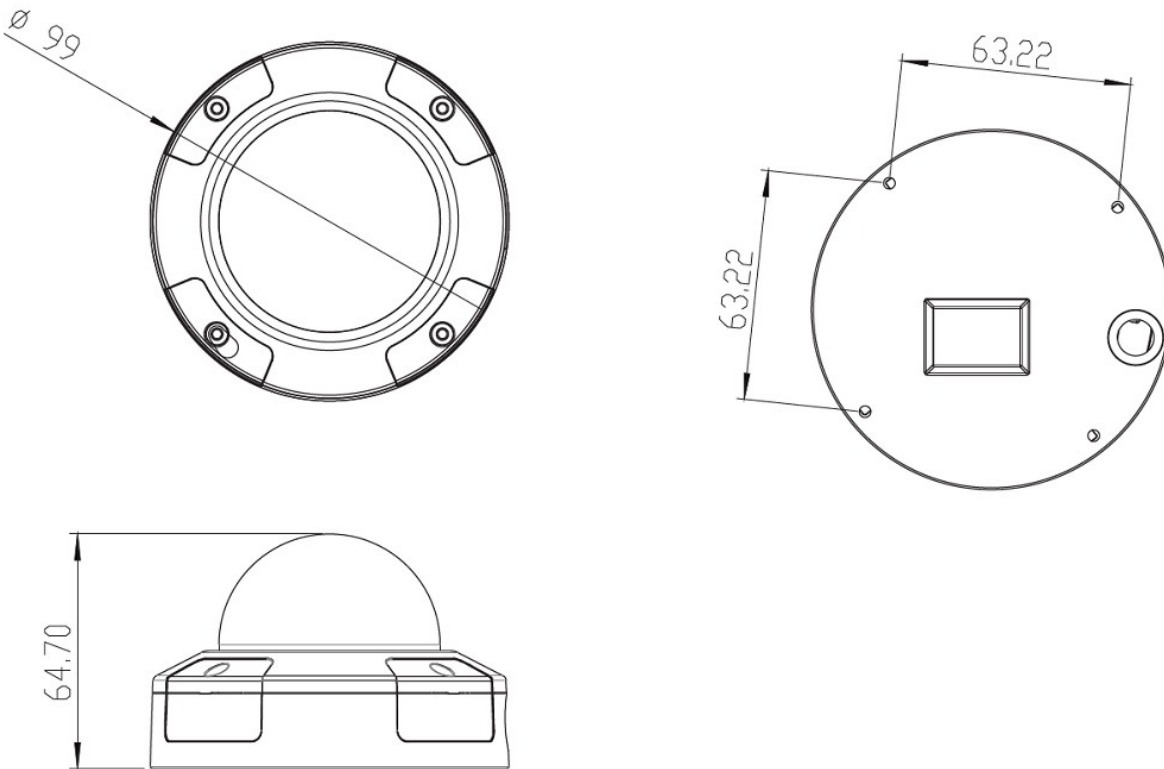









Unit: mm [inch]

## ▶ Ordering Information

A94-B	5MP Outdoor Mini Dome with D/N, Adaptive IR, Advanced WDR, SLLS, Fixed lens, f2.8mm/F1.85 (HOV:80.04°), H.265/H.264, 1080p/30fps, 2D+3D DNR, MicroSDHC/MicroSDXC, PoE/DC12V, IP66, IK10. Installation cable at the back.
A94-S	5MP Outdoor Mini Dome with D/N, Adaptive IR, Advanced WDR, SLLS, Fixed lens, f2.8mm/F1.85 (HOV:80.04°), H.265/H.264, 1080p/30fps, 2D+3D DNR, MicroSDHC/MicroSDXC, PoE/DC12V, IP66, IK10. Installation cable at the side.

## ▶ Related Products

### Mounting Accessories - Camera Mount

PMAX-0122		Straight Tube (for A71, A88, A9x,)
PMAX-0123		Extension Tube (for A71, A88, A9x,)
PMAX-0318		Wall Mount (for A91, A92, Z91, A61, A62)
PMAX-0506		Pole Mount (for A31, A4x, E78, E9x, E9xx), supports 2" to 3" Poles
PMAX-0715		Junction Box (for A88, A92, A94, A96)
PMAX-0812		Gang Box Converter (for A88, A92, A94, A96), supports 4" Round and 4" Octagon Boxes
PMAX-0816		Converter Ring, 1.0" NPT for Third-Party Mounting Accessories, White
PMAX-1402		Mount Kit (for A91, A92, Z91, A61, A62, A71)

**Note:** Some mounting accessories may need additional accessories for installation. Please check [www.acti.com/mountingselector](http://www.acti.com/mountingselector) for more information.

### Dome Covers - Transparent Dome Cover

R701-50007		Transparent Dome Cover (for A92,A94,A96)
------------	---	--

### Power Supply Accessories - Power Adapter

PPBX-0012		Power Adapter AC 100~240V (US), for A3x, A4x, A88, A9x, Z31, Z8x, Z9x
PPBX-0013		Power Adapter AC 100~240V (EU), for A3x, A4x, A88, A9x, Z31, Z8x, Z9x
PPBX-0014		Power Adapter AC 100~240V (UK), for A3x, A4x, A88, A9x, Z31, Z8x, Z9x