

# B915

## 3MP Outdoor Speed Dome with D/N, Adaptive IR, Extreme WDR, SLLS, 36x Zoom Lens



- 3 Megapixel
- Day & Night with Superior Low Light Sensitivity and Adaptive IR LED
- 36x Zoom Lens with f4.6-165.6mm/F1.55-F5.0, DC iris, Auto focus
- Extreme WDR
- Endless Pan & Tilt
- H.265 Compression
- Event trigger, response and notification

### ► Specifications

#### Device

Product Type	Speed Dome
Maximum Resolution	3MP
Application Environment	Outdoor
Image Sensor	Progressive Scan CMOS
Sensor Size	1/2.8 "
Effective Pixels	2065(H) X 1553(V) (3.21 MP)
Day / Night	Yes
Low Light Sensitivity	Superior
Minimum Illumination	Color: 0.1 lux at F1.55 (30 IRE, 2400 K); B/W: 0 lux at F1.55 (IR LED on)
Color to B/W Switch	ISP based switch, configurable
Mechanical IR Cut Filter	Yes
IR Sensitivity Range	700-1100nm
IR LED	Adaptive IR LED
IR Working Distance	150m
Electronic Shutter	1/5-1/64000 second (manual mode); 1/5-1/64000 second (auto mode)
Horizontal Resolution (TV Lines)	1450 TVL

S/N Ratio	59 dB
-----------	-------

## Lens

Focal Length	Zoom, f4.6-165.6mm
Aperture	F1.55-F5.0
Zoom Ratio	36x optical, 16x digital
Zoom Application	Camera Installation, Auto Zoom by Event, Manual Operation
Iris	DC iris
Focus	Learning-based Auto Focus
Lens Mount	Board mount
Horizontal Viewing Angle	57.6° - 2.35°
Vertical Viewing Angle	44.9° - 1.78°

## PTZ

Scan Panning / Tilting Speed	1.6° - 64°/second, 1.6° - 32°/second
Manual Panning / Tilting Speed	0.16° - 54.4°/second, 0.16° - 27.2°/second
Preset Panning / Tilting Speed	0.16° - 300°/second, 0.16° - 150°/second
Panning Range	360° endless
Tilting Range	-20°~200°
PTZ Control	Remote manual control, 256 preset points, 10 preset tours
Absolute Position	Yes
Pan, Tilt or Zoom protocol	Visca, Pelco-D, Pelco-P, ACTi URL command

## Video

Compression	H.265, H.264 (Baseline/ Main/ High profile), MJPEG
Maximum Frame Rate vs. Resolution	30 fps at 2048 x 1536 60 fps at 1920 x 1080 (*) 30 fps at 1280 x 960 60 fps at 1280 x 720 (*) 30 fps at 800 x 600 30 fps at 640 x 480 30 fps at 320 x 240
Multi-Streaming	Simultaneous triple streams based on three configurations
Bit Rate	128Kbps - 12Mbps (per stream)
Bit Rate Mode	Constant, Variable
Wide Dynamic Range	Extreme WDR (145 dB)
Image Enhancement	White Balance, Brightness, Contrast, Saturation, Sharpness, Automatic gain control, Flickerless, Digital Image Stabilizer (DIS, EIS)(*), Defogging
Digital Noise Reduction	2D + 3D DNR
Privacy Mask	32 configurable 3D privacy masks (To be available through future firmware upgrade)
Text Overlay	Yes
Built-in Analytics	Object Based Motion Detection, Tampering Detection, Shock Detection
Server-based Analytics	Object Line Counting, People Counting, Face Detection, Object Based Motion Detection, Tamper, Object Line Crossing Detection, Object Enter Area Detection, Missing Object Detection, Unattended Object Detection, Smoke Detection, Heat Map, Dwell Time, Direction Detection, Automatic License Plate Recognition, People Queue Detection, (Require PC-based or standalone IVS or ALPR Server. Contact ACTi support for recommendations on how to maximize analytical accuracy)
Image Orientation	Flip, Mirror

**Audio**

Audio Type	2-way, Line-in, Line-out
Audio Compression	8 kHz, 16 bit encoding, Mono, PCM, G.711

**Network**

Network Protocol & Service	IPv4/v6, TCP, UDP, DHCP, PPPoE, HTTP, HTTPS, DNS, DDNS, NTP, RTP, RTSP, RTCP, SMTP, FTP, IGMP, ICMP, ARP, Bonjour, UPnP, QoS, SNMP, IEEE 802.1X
Ethernet Port	1 x RJ-45 pigtail connector
Security	IP address filtering, HTTPS encryption, Password protected user level, Anonymous login, IEEE 802.1X network access control

**Event**

Event Trigger	Video motion detection (10 included and excluded polygons regions), External device through digital input, Sound detection, Tampering detection, Shock Detection
Event Response	Notify control center, Go to PTZ preset point or preset tour, Change camera settings, Command other devices, E-mail notification with snapshots, Push notification to mobile device, Save video to local storage, Upload video to NVR server, Upload video or snapshot to FTP server, Activate external device through digital output

**Integration**

Unified Solution	Fully compatible with ACTi software
GPS Position	Manual setting
ONVIF Compliant	Yes, Profile S, Profile G, Profile T, Profile Q
GB28181 Compliant	Yes
Web Browser	IE 11
Auto Firmware Upgrade	Yes

**Interface**

Local Storage	MicroSDHC, MicroSDXC Memory Card Slot (card not included, up to 256GB)
Digital Input/Output	4/2

**General**

Power Source	AC 24V, High PoE
Power Consumption	52 W (PoE, heater, fan and IR on), 62 W (AC, heater, fan and IR on)
Weight	3146g (6.936lb)
Dimensions	(Ø x H): 170mm x 260mm (6.69" x 10.24")
Environmental Casing	Weatherproof (IP66), Vandal proof metal casing (IK10), Built-in dehumidifier, Scratch-resistant and water-repellent lens glass
Bundled Accessories	High PoE injector (for USA) or Power Adapter (for other countries)
Mount Type	Wall Mount, Pendant, Corner Mount, Pole Mount, Gang Box
Fan	Yes
Heater	Yes
Dehumidifier	Yes
Starting Temperature	-40°C ~ 55°C (-40°F ~ 131°F) within 30 minutes
Operating Temperature	-40°C ~ 55°C (-40°F ~ 131°F)
Operating Humidity	10% - 85% RH

Approvals	CE, FCC, IP66, NEMA 4X, IK10 (metal casing), UL (for bundled power adapter)
Warranty	3 Year(s) (1 year in continuous motion). For extended warranty offering, see <a href="http://www.acti.com/support/warranty">http://www.acti.com/support/warranty</a>

### ▶ Photo Indication

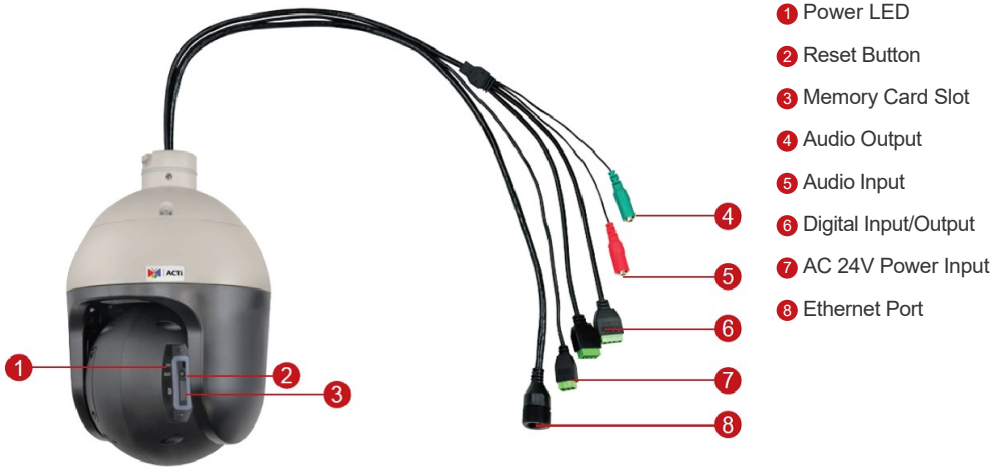

### ▶ Dimension Diagram

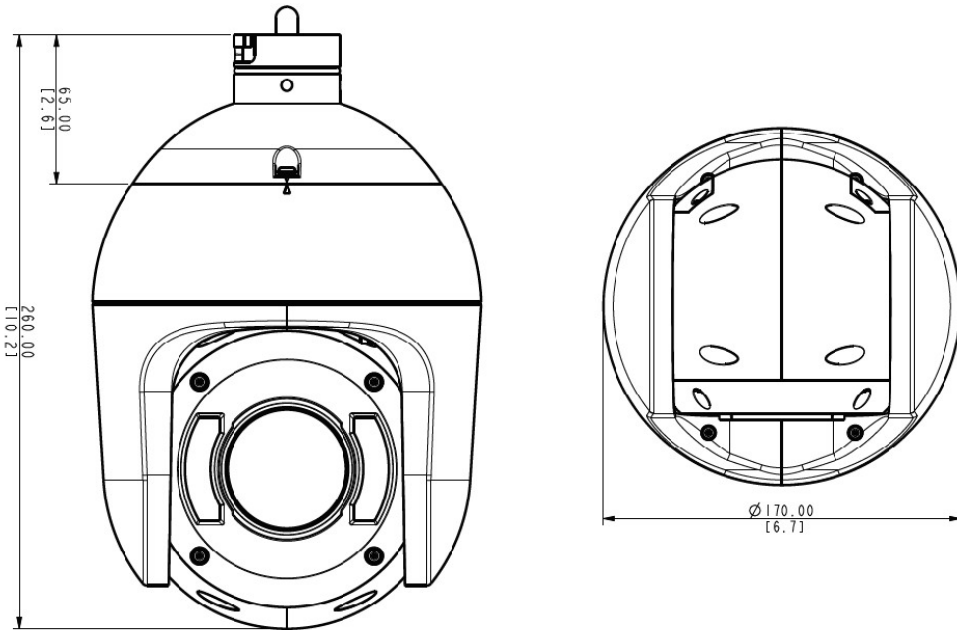













Unit: mm [inch]

Unit: mm [inch]

## ▶ Related Products

### Mounting Accessories - Camera Mount

PMAX-0102		Straight Tube
PMAX-0103		Straight Tube with Bracket
PMAX-0104		Extension Tube
PMAX-0302		Gooseneck with Bracket
PMAX-0303		Gooseneck
PMAX-0312		PTZ Wall Mount for Outdoor PTZ / Speed Dome (except KCM-8211 & TCM-6630)
PMAX-0402		Corner Mount
PMAX-0503		Pole Mount (for PMA-0102, PMA-0312, PMA-0313, PMA-0314, PMA-0702, PMA-1106, PMA-1107), supports 5.25" to 8.5" Poles
PMAX-0505		Pole Mount (for B4x, B41x, E44, E45, E46, E48, E44A, E45A, E46A, E41x, I4x, PMA-0312, PMA-0313, PMA-0314, PMA-0330), supports 2" to 3" Poles
PMAX-0702		Junction Box for PTZ and Dome Cameras
PMAX-0807		Gangbox Converter (for PMA-0102, PMA-0312, PMA-0313, PMA-0314, PMA-0321), supports Two-Gang Boxes
PMAX-0808		Converter Ring, 1.5" NPT for Third-Party Mounting Accessories

**Note:** Some mounting accessories may need additional accessories for installation. Please check [www.acti.com/mountingselector](http://www.acti.com/mountingselector) for more information.



### Power Supply Accessories - Power Adapter





PPBX-0008		Power Adapter AC 100~240V, with universal connectors for PLED-0203~PLED-0205
-----------	---	--

### Power Supply Accessories - PoE Injector

PPOE-0102		High PoE Injector IEEE 802.3at compliant, AC 100~240V, with universal connectors (for I93~I910, KCM-8211)
-----------	---	---

### Network & Storage Peripherals - Data Switch

PPSW-0100		PLANET FGSD-910HP 8-Port 802.3at PoE Switch (PoE Budget 120W)
PPSW-0101		PLANET GS-4210-8P2T2S 8-Port Gigabit 802.3at Managed PoE Switch (PoE Budget 240W)

PPSW-0102		PLANET FGSD-1011HP 8-Port 802.3at PoE Switch (PoE Budget 120W)
PPSW-1101		PLANET GS-4210-24PL4C 24-Port Gigabit 802.3at Managed PoE Switch (PoE Budget 440W)
PPSW-2101		4-Port 802.3at PoE Switch (PoE Budget 62W)
PPSW-3100		PLANET FGSW-1816HPS 16-Port 802.3at PoE Switch (PoE Budget 220W)

### Extenders - PoE Extender

PPEX-0100		Veracity OUTREACH Max Power over Ethernet (PoE) Extender
-----------	---	--

### Extenders - PoE over Coaxial Extender Kit

PPOC-0100		Planet LRP-101C-KIT Power over Coax Adapter Kit
-----------	---	---



### Audio Devices - Microphone

PMIC-0100		Active Microphone Omnidirectional for all Cameras with Line-in Audio
-----------	---	--

### Illuminators - IR LED Illuminator

PLED-0200		SPINLUX (SL-A2IRXX10-24CL) IR Illuminator 10° Angle with 120 m approx. range
PLED-0201		SPINLUX (SL-A2IRXX25-24CL) IR Illuminator 25° Angle with 50 m approx. range
PLED-0202		SPINLUX (SL-A2IRXX35-24CL) IR Illuminator 35° Angle with 25 m approx. range

### Installation Support - Camera Installation Kit

PMON-1001-010		Camera Installation Kit for use with iOS Device with belt bag, battery and charger (US, AC 110~240V)
PMON-2000		Camera Installation Kit