

E44A

2MP with D/N, Adaptive IR, Basic WDR, SLLS, Vari-focal Lens



- 2 Megapixel
- Day & Night with Superior Low Light Sensitivity and Adaptive IR LED
- Vari-focal Lens with f2.8-12mm/F1.4
- Basic WDR
- Wide Angle
- Event trigger, response and notification

► Specifications

Device

Product Type	Bullet
Maximum Resolution	2MP
Application Environment	Outdoor
Image Sensor	Progressive Scan CMOS
Sensor Size	1/2.8 "
Effective Pixels	1984(H) X 1225(V) (2.43 MP)
Day / Night	Yes
Low Light Sensitivity	Superior
Minimum Illumination	Color: 0.1 lux at F1.4 (30 IRE, 2400 K); B/W: 0 lux at F1.4 (IR LED on)
Color to B/W Switch	ISP based switch, configurable
Mechanical IR Cut Filter	Yes
IR Sensitivity Range	700-1100nm
IR LED	Adaptive IR LED x 15 (850 nm)
IR Working Distance	30m (0 lux, 30IRE, Gain 255, Auto shutter mode)
Electronic Shutter	1/5-1/2000 second (manual mode); 1/5-1/10000 second (auto mode)
Horizontal Resolution (TV Lines)	1100 TVL

S/N Ratio	52 dB
-----------	-------

Lens

Focal Length	Vari-focal, f2.8-12mm
Aperture	F1.4
Iris	Fixed iris
Focus	Manual focus
Lens Mount	Board mount
Horizontal Viewing Angle	92.5° - 35.9°
Vertical Viewing Angle	50.0° - 18.6°

Video

Compression	H.264 (Baseline/ Main/ High profile), MJPEG
Maximum Frame Rate vs. Resolution	30 fps at 1920 x 1080 30 fps at 1280 x 720 30 fps at 800 x 600 30 fps at 640 x 480 15 fps at 320 x 240
Multi-Streaming	Simultaneous dual streams based on two configurations
Bit Rate	28Kbps - 6Mbps (per stream)
Bit Rate Mode	Constant, Variable
Wide Dynamic Range	Basic WDR (75 dB)
Image Enhancement	White Balance, Brightness, Contrast, Sharpness, Automatic gain control, Flickerless
Digital Noise Reduction	DNR
Privacy Mask	4 configurable regions
Text Overlay	Yes
On-Screen Graphics	Yes
Server-based Analytics	Object Line Counting, People Counting, Face Detection, Object Based Motion Detection, Tamper, Object Line Crossing Detection, Object Enter Area Detection, Missing Object Detection, Unattended Object Detection, Smoke Detection, Heat Map, Dwell Time, Direction Detection, Automatic License Plate Recognition, People Queue Detection, (Require PC-based or standalone IVS or ALPR Server. Contact ACTi support for recommendations on how to maximize analytical accuracy)
Image Orientation	Flip, Mirror

Audio

Audio Type	2-way, Line-in, Line-out
Audio Compression	8 kHz, 16 bit encoding, Mono, PCM, G.711

Network

Network Protocol & Service	IPv4/v6, TCP, UDP, DHCP, PPPoE, HTTP, HTTPS, DNS, DDNS, NTP, RTP, RTSP, RTCP, SMTP, FTP, IGMP, ICMP, ARP, Bonjour, UPnP, QoS, SNMP, IEEE 802.1X
Ethernet Port	1 x RJ-45 pigtail connector
Security	IP address filtering, HTTPS encryption, Password protected user level, Anonymous login, IEEE 802.1X network access control

Event

Event Trigger	Video motion detection (3 regions), External device through digital input, Sound detection, Tampering detection
---------------	---

Event Response

Notify control center, Change camera settings, Command other devices, E-mail notification with snapshots, Play the audio file, Push notification to mobile device, Save video to local storage, Upload video or snapshot to FTP server, Upload video to NVR server, Activate external device through digital output

Integration

Unified Solution	Fully compatible with ACTi software
Software Development Kit	Yes
GPS Position	Manual setting
ONVIF Compliant	Yes, Profile S, Profile G, Profile T* (To be available through future firmware upgrade), Profile Q
GB28181 Compliant	Yes
Web Browser	IE 11
Auto Firmware Upgrade	Yes

Interface

Audio Interface	Cable with 3.5mm Phone Jack
Local Storage	MicroSDHC, MicroSDXC Memory Card Slot (card not included, up to 256GB)
Digital Input/Output	1/1

General

Power Source	PoE Class 2 (IEEE802.3af)
Power Consumption	5.76 W (PoE, IR on)
Weight	1007g (2.22lb)
Dimensions	(Ø x L): 77mm x 291mm (3" x 11.4")
Environmental Casing	Weatherproof (IP68), Vandal proof metal casing (IK10)
Bundled Accessories	Integrated bracket
Mount Type	Gang Box, Integrated Bracket, Pole Mount
Starting Temperature	-20°C ~ 50°C (-4°F ~ 122°F)
Operating Temperature	-40°C ~ 50°C (-40°F ~ 122°F)
Operating Humidity	10% - 85% RH
Approvals	CE, FCC, BIS, IP68, IK10 (metal casing), UL (for optional PoE injector)
Warranty	3 Year(s). For extended warranty offering, see http://www.acti.com/support/warranty

► Photo Indication

Side



Back



- 1 Ethernet Port
- 2 Audio Input
- 3 Audio Output
- 4 Digital Input/Output



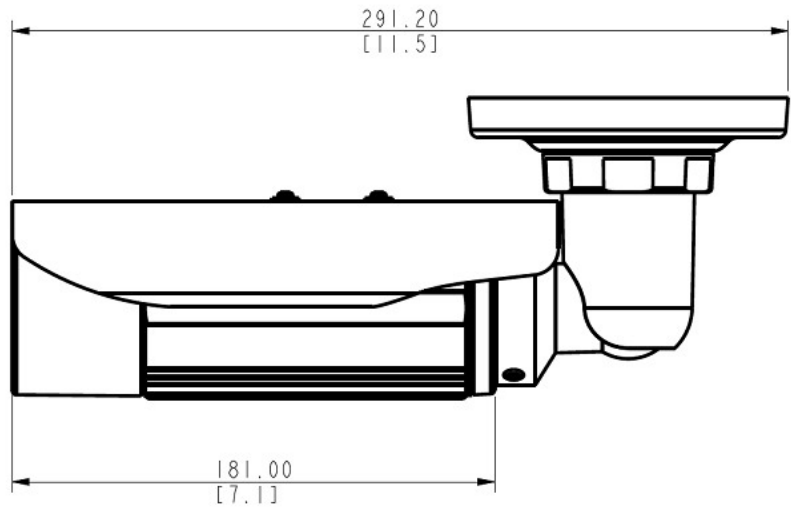
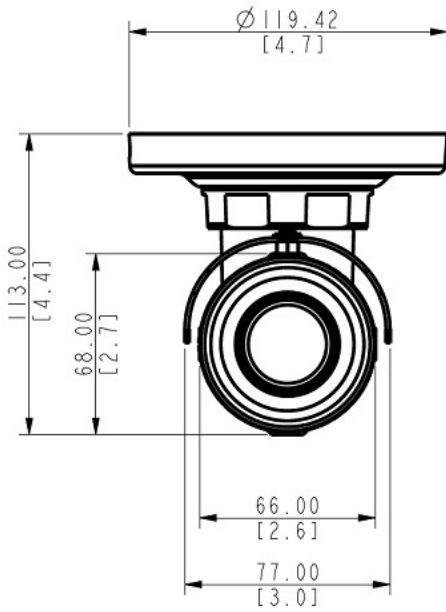

► Dimension Diagram



Unit: mm [inch]

▶ Related Products

Mounting Accessories - Camera Mount

PMAX-0504		Pole Mount (for B4x, B41x, E44, E45, E46, E48, E44A, E45A, E46A, E41x, I4x, PMAX-0330), supports 3.25" to 7.0" Poles
PMAX-0505		Pole Mount (for B4x, B41x, E44, E45, E46, E48, E44A, E45A, E46A, E41x, I4x, PMAX-0312, PMAX-0313, PMAX-0314, PMAX-0330), supports 2" to 3" Poles
PMAX-0508		Pole Mount (for PMAX-0203, PMAX-0204, PMAX-0205, PMAX-0206, PMAX-0704), supports 3" to 9" Poles
PMAX-0704		Junction Box (for A4x, B4x, B41x, E44, E45, E46, E48, E44A, E45A, E46A, E41x, I4x, PMAX-0203~PMAX-0205)
PMAX-0806		Gang Box Converter (for B4x, E39, E44, E45, E46, E44A, E45A, E46A), supports 4" Round and 4" Octagon Boxes

Note: Some mounting accessories may need additional accessories for installation. Please check www.acti.com/mountingselector for more information.



Bullet Covers - Back Cover

R706-00003		Back Cover with Pre-installed Network Cable (for E44~E46, E44A~E46A)
------------	---	--







Bullet Covers - Front Cover

R700-00005		Front Cover (for D4x, E4x bullet cameras, except E48)
------------	---	---

Power Supply Accessories - PoE Injector

PPOE-0000		POE Injector , IEEE 802.3af compliant, AC 100~240V, for US & Japan
PPOE-0001		PoE Injector IEEE 802.3af compliant, AC 100~240V, with universal connectors

Network & Storage Peripherals - Data Switch

PPSW-0100		PLANET FGSD-910HP 8-Port 802.3at PoE Switch (PoE Budget 120W)
PPSW-0101		PLANET GS-4210-8P2T2S 8-Port Gigabit 802.3at Managed PoE Switch (PoE Budget 240W)
PPSW-0102		PLANET FGSD-1011HP 8-Port 802.3at PoE Switch (PoE Budget 120W)
PPSW-1101		PLANET GS-4210-24PL4C 24-Port Gigabit 802.3at Managed PoE Switch (PoE Budget 440W)
PPSW-2101		4-Port 802.3at PoE Switch (PoE Budget 62W)
PPSW-3100		PLANET FGSW-1816HPS 16-Port 802.3at PoE Switch (PoE Budget 220W)

Extenders - PoE Extender

PPEX-0100  Veracity OUTREACH Max Power over Ethernet (PoE) Extender

Extenders - PoE over Coaxial Extender Kit

PPOC-0100  Planet LRP-101C-KIT Power over Coax Adapter Kit

Audio Devices - Microphone

PMIC-0100  Active Microphone Omnidirectional for all Cameras with Line-in Audio

Illuminators - IR LED Illuminator

PLED-0200  SPINLUX (SL-A2IRXX10-24CL) IR Illuminator 10° Angle with 120 m approx. range

PLED-0201  SPINLUX (SL-A2IRXX25-24CL) IR Illuminator 25° Angle with 50 m approx. range

PLED-0202  SPINLUX (SL-A2IRXX35-24CL) IR Illuminator 35° Angle with 25 m approx. range

Product Demo - Camera Demo Kit

PCDK-0001  Camera Demo Kit Rack Box (350 x 550 x 140 mm) for all cameras except Mini Domes

Installation Support - Camera Installation Kit

PMON-1001-010  Camera Installation Kit for use with iOS Device with belt bag, battery and charger (US, AC 110~240V)

PMON-1001-011  Camera Installation Kit for use with iOS Device with belt bag, battery and charger (Europe, AC 110~240V)

PMON-2000  Camera Installation Kit