

Z950

2MP Outdoor Speed Dome with D/N, Adaptive IR, Superior WDR, SLLS, 20x Zoom Lens



- 2 Megapixel
- Day & Night with Superior Low Light Sensitivity and Adaptive IR LED
- Superior WDR
- Endless Pan & Tilt
- H.265 Compression
- Event trigger, response and notification

► Specifications

Device

Product Type	Speed Dome
Maximum Resolution	2MP
Application Environment	Outdoor
Image Sensor	Progressive Scan CMOS
Sensor Size	1/2.8 "
Day / Night	Yes
Low Light Sensitivity	Superior
Minimum Illumination	Color: 0.001 lux at F1.5 (AGC on); B/W: 0 (IR LED on)
Mechanical IR Cut Filter	Yes
IR LED	Adaptive IR LED
IR Working Distance	150m
Electronic Shutter	1-1/100000 second (manual mode); 1-1/100000 second (auto mode)
S/N Ratio	54 dB

Lens

Focal Length	Zoom, f5.2-104mm
Aperture	F1.5-F3.0

Zoom Ratio	20x optical, 16x digital
Focus	Auto focus
Lens Mount	Board mount
Horizontal Viewing Angle	55.93° - 3.52°
Vertical Viewing Angle	33.25° - 1.98°

PTZ

Manual Panning / Tilting Speed	0.1° - 240°/second, 0.1° - 160°/second
Preset Panning / Tilting Speed	0° - 300°/second, 0° - 240°/second
Panning Range	360° endless
Tilting Range	-15°~90°

Video

Compression	H.265, H.264 (Baseline/ Main/ High profile), MJPEG
Maximum Frame Rate vs. Resolution	30 fps at 1920 x 1080 25 fps at 1920 x 1080 30 fps at 1280 x 720 25 fps at 1280 x 720
Multi-Streaming	Simultaneous triple streams
Wide Dynamic Range	Superior WDR (120 dB)
Image Enhancement	Defogging
Digital Noise Reduction	2D + 3D DNR
Privacy Mask	Yes
Text Overlay	Yes

Audio

Audio Type	2-way, Line-in, Line-out
Audio Compression	G.711

Network

Network Protocol & Service	IPv4, TCP, UDP, DHCP, PPPoE, HTTP, HTTPS, DNS, DDNS, NTP, RTP, RTSP, RTCP, SMTP, FTP, IGMP, ICMP, ARP, UPnP, QoS, SNMP, SSL, IEEE 802.1X
Ethernet Port	1 x Ethernet (10/100 Base-T), RJ-45 connector

Event

Event Trigger	Video motion detection, Tampering detection, External device through digital input,
Event Response	Save video to local storage, Activate external device through digital output

Integration

ONVIF Compliant	Yes, Profile S, Profile G, Profile T
-----------------	--------------------------------------

Interface

Local Storage	MicroSDHC Memory Card Slot (card not included, up to 256GB)
Digital Input/Output	1/1

General

Power Source	DC 24V, AC 24V
Power Consumption	42 W (AC, heater and IR on)

Weight	5280g (11.6lb)
Dimensions	(Ø x H): 227mm x 359.4mm (8.9" x 14.2")
Environmental Casing	Weatherproof (IP66), Vandal proof metal casing (IK10)
Bundled Accessories	Power Adapter
Heater	Yes
Operating Temperature	-40°C ~ 65°C (-40°F ~ 149°F)
Operating Humidity	10% - 95% RH
Approvals	CE, FCC, IP66, IK10 (metal casing)
Warranty	2 Year(s). For extended warranty offering, see http://www.acti.com/support/warranty

▶ Photo Indication

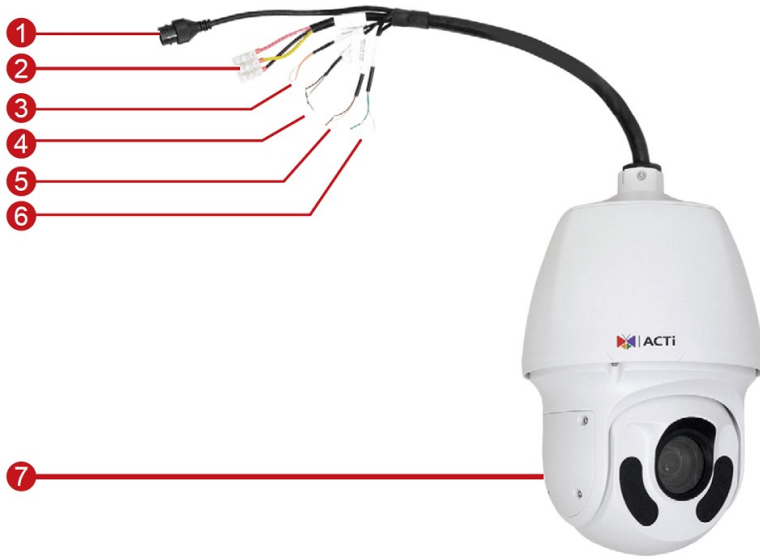

- 1 Ethernet Port
- 2 AC24V / DC24V Power Input
- 3 Digital Output
- 4 Digital Input
- 5 Audio Input
- 6 Audio Output
- 7 Memory Card Slot (inside the back panel cover)

▶ Dimension Diagram

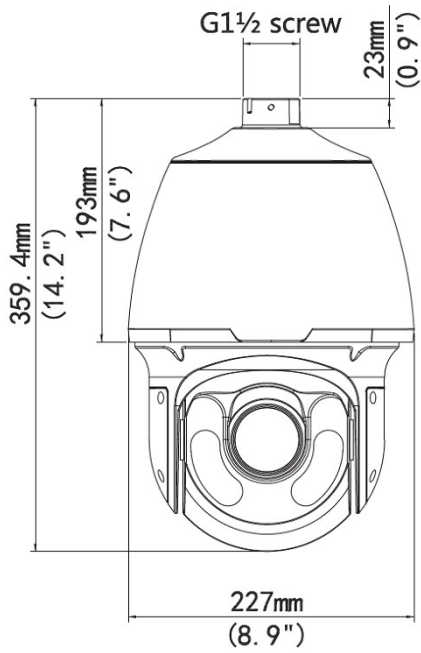







Unit: mm [inch]

Unit: mm [inch]

▶ Related Products

Mounting Accessories - Camera Mount

PMAX-0115		Pendant Mount (for Z950)
PMAX-0116		Straight Tube, 200 mm (for Z950)
PMAX-0117		Straight Tube (for Z950)
PMAX-0322		Wall mount (for Z950)
PMAX-0404		Corner Mount (for Z950)
PMAX-0513		Pole Mount (for Z950)
PMAX-0711		Junction box (for Z950)

Note: Some mounting accessories may need additional accessories for installation. Please check www.acti.com/mountingselector for more information.

Network & Storage Peripherals - Data Switch

PPSW-0102		PLANET FGSD-1011HP 8-Port 802.3at PoE Switch (PoE Budget 120W)
-----------	---	--

Audio Devices - Microphone

PMIC-0100		Active Microphone Omnidirectional for all Cameras with Line-in Audio
-----------	---	--